

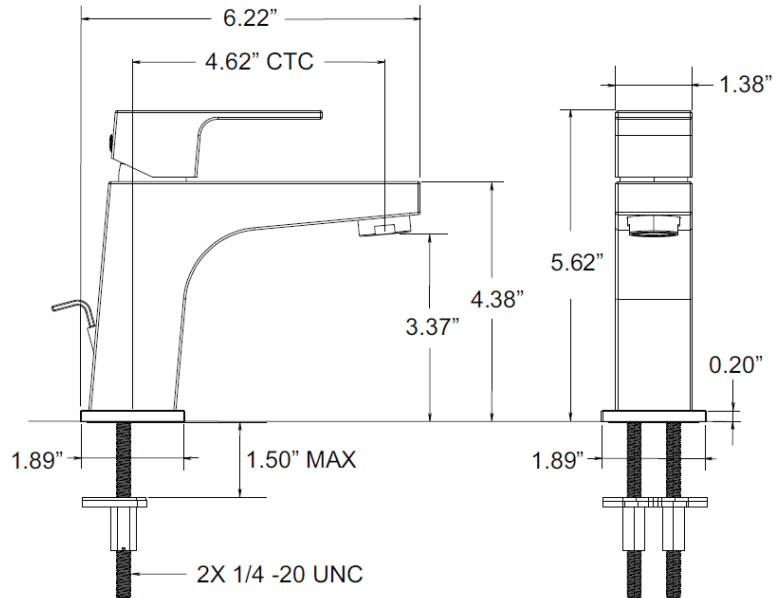

## Model # 5214

### INSTRUCTIONS

1. Install the faucet body into the hole of the mounting surface so that it is centered in the hole.
2. From underneath the countertop, place the large U-bracket over the long fixed brass bolt. Feed all hoses through the opening in the large U-bracket.
3. Connect the hot and cold water supply lines to the wall water supply valves.
4. Remove the aerator and turn the water on to flush the system. Replace the aerator and check for any leaks.



### CARE AND MAINTENANCE

Minimum Maintenance is required to maintain product finish. With proper maintenance your CHEVIOT Faucet will continually look like new. Special care should be taken when cleaning your faucet and the following suggestions should help extend your faucet life.

- a) Cleaning should be done regularly using a soft cotton cloth and warm water, then towel dry.
- b) Do not use cleaners that contain abrasives or harsh chemicals; Care should be taken in selecting cleaning supplies. Many cleaners contain detergents, ammonia, or other corrosive solvents that could damage your faucet finish.
- c) occasionally clean with a non-abrasive wax polish.

Tel: (800)-444-5969

[www.cheviotproducts.com](http://www.cheviotproducts.com)