

-  ISTRUZIONI DI MONTAGGIO - Termostatici incasso
-  INSTALLATION INSTRUCTIONS - Concealed Thermostatic
-  INSTRUCTION DE MONTAGE - Thermostatique à encastrer

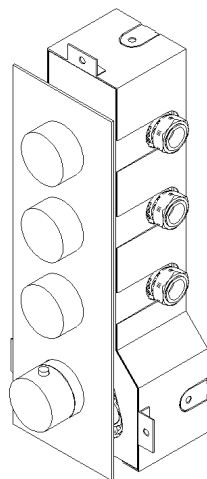

Grazie per aver scelto Rubinetterie Treemme. Perché il Suo rubinetto funzioni correttamente e possa durare nel tempo, occorre che vengano rispettate le procedure di installazione ed manutenzione illustrate in questo opuscolo.

Thank you for selcting Rubinetterie Treemme. In order to allow a proper functioning of your fittine and a longlasting reliability, you must carefully observe our care and installation instruction described on this brochure.

Nous vous remercions d'avoir chiosi Rubinetterie Treemme. Afin que cet appareil fonctionne d'une manière correcte et puisse durer longtemps, il convient de respecter les modalités d'installation et d'entretien indiquées dans cette notice.

Preliminari - Prima di procedere all'installazione è necessario pulire accuratamente le tubature per eliminare eventuali detriti in esse presenti

Preliminary information - Before starting with the installation it is necessari to clean the pipes carefully in order to eliminate any deposit which may be found inside them.

Preliminaires - Avant de monter les mitigeur, il faut bien nettoyer les tuyuex pour éliminer toutes les impuretés à l'intérieur.



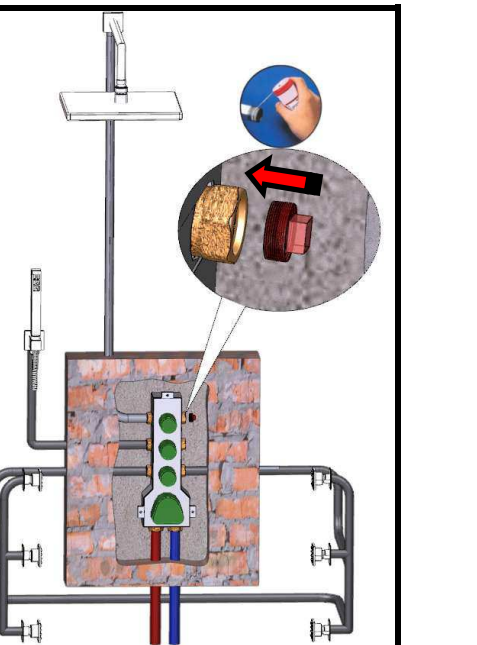
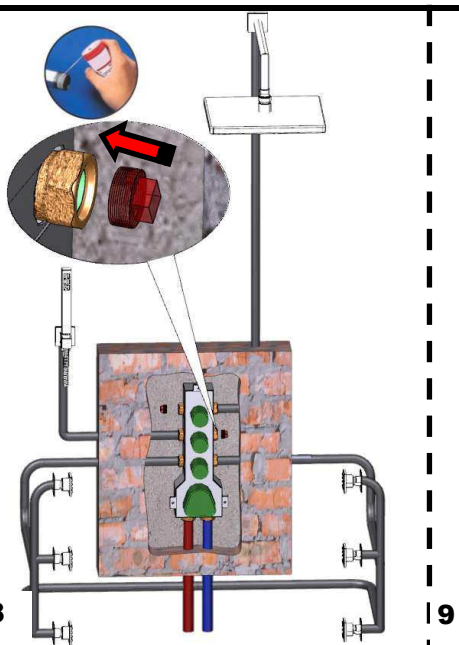
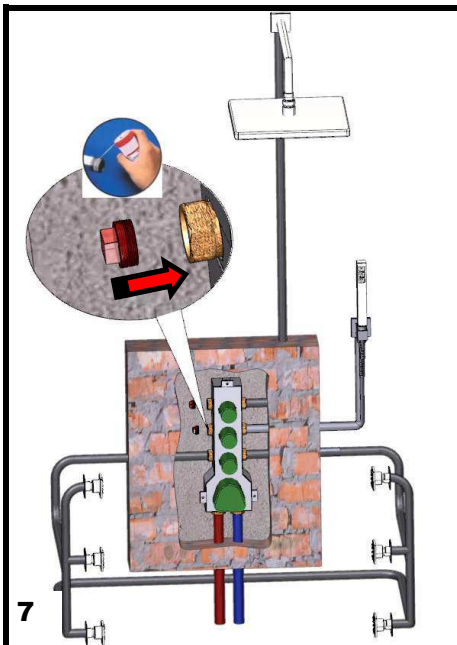
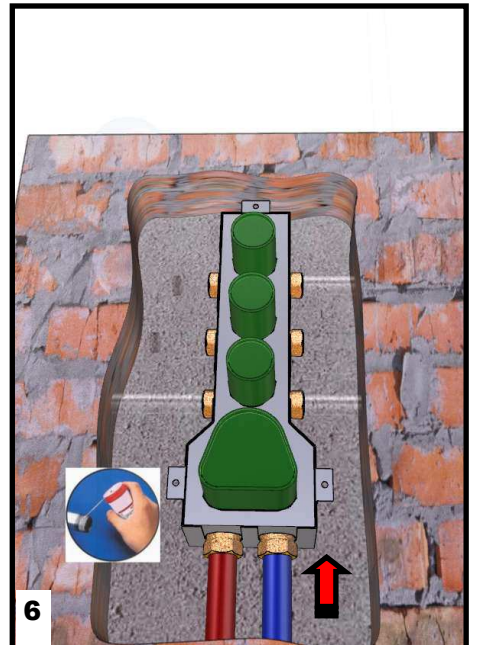
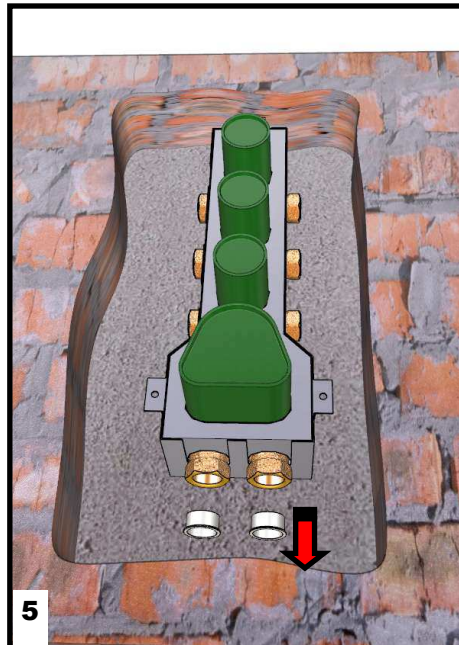
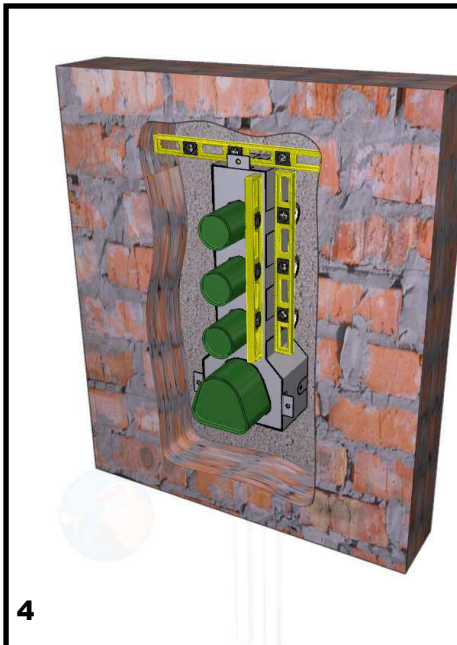
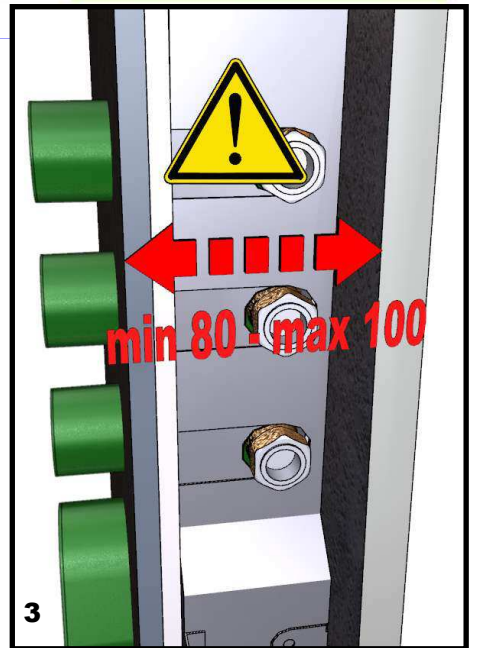
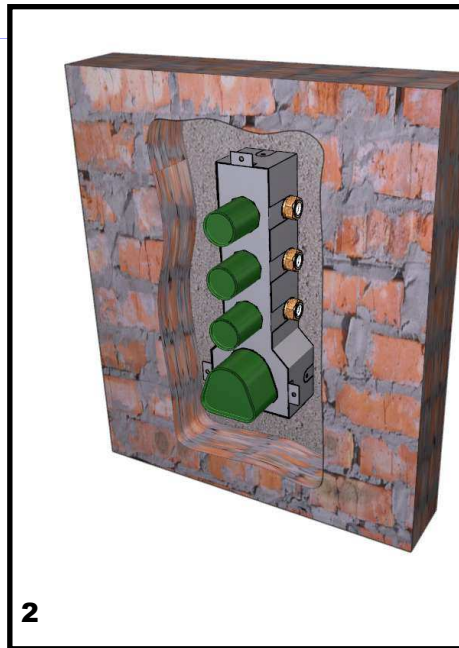
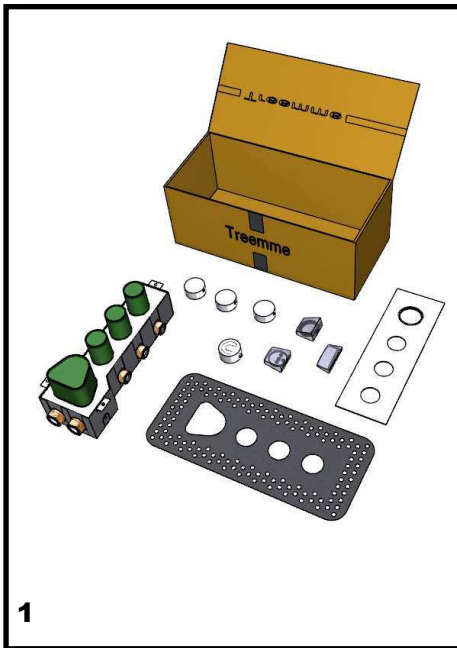

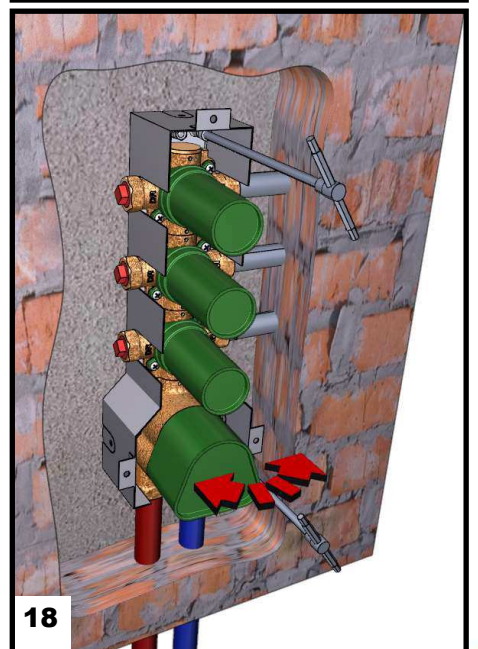
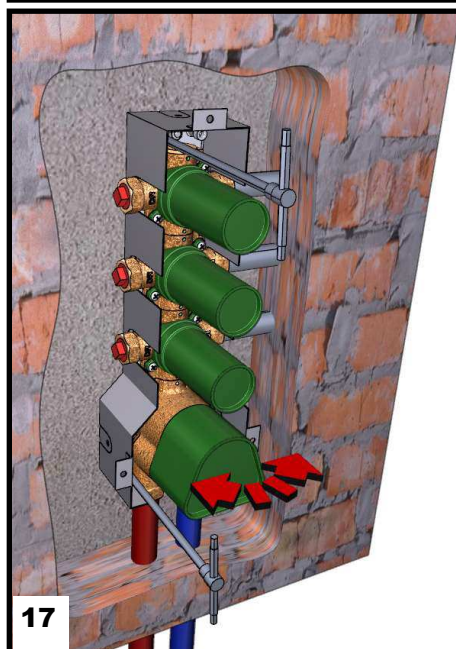
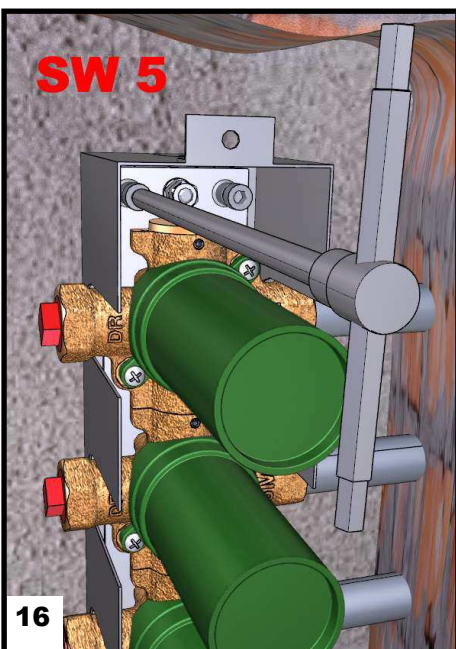
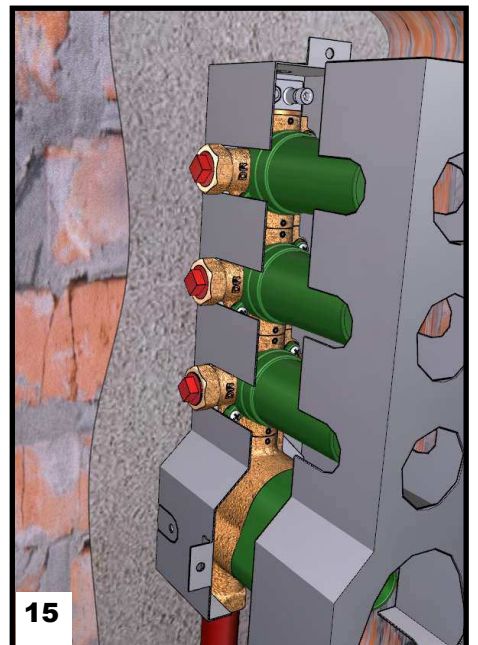
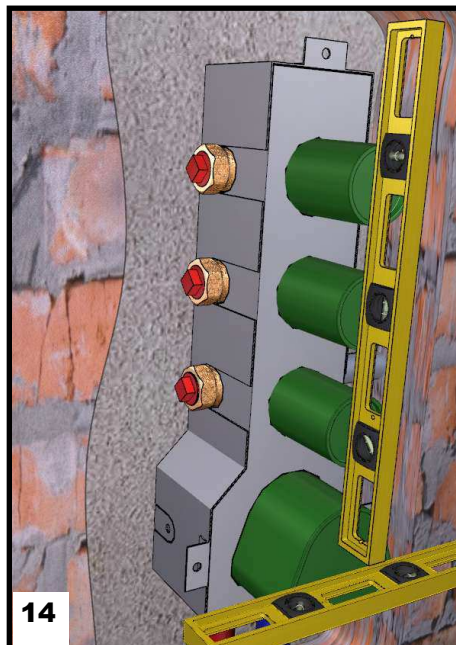
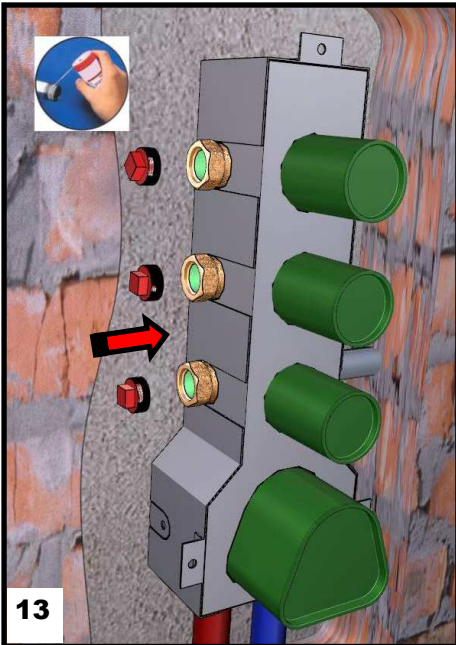
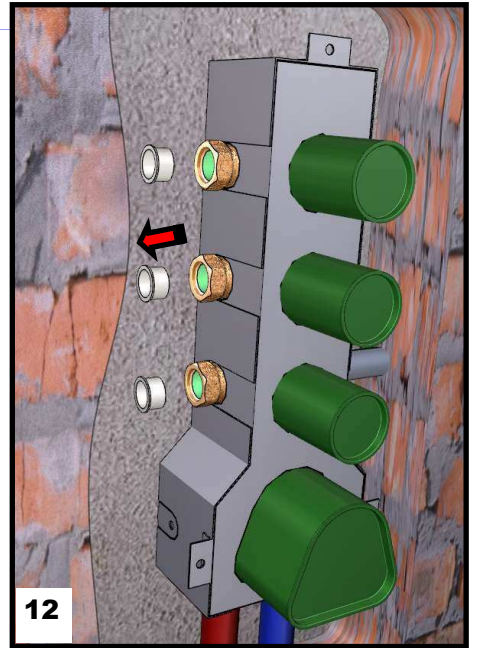
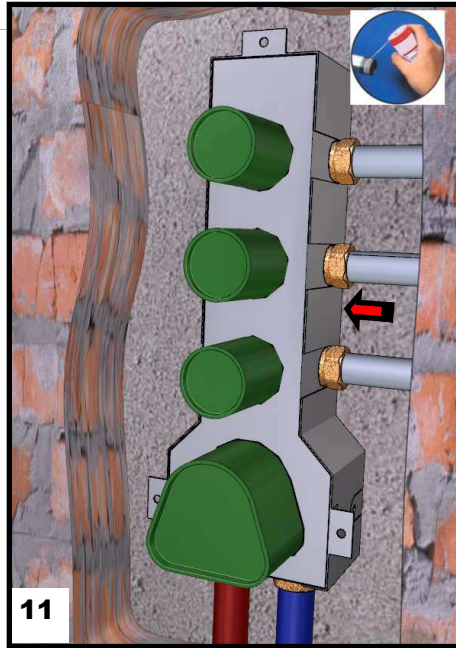
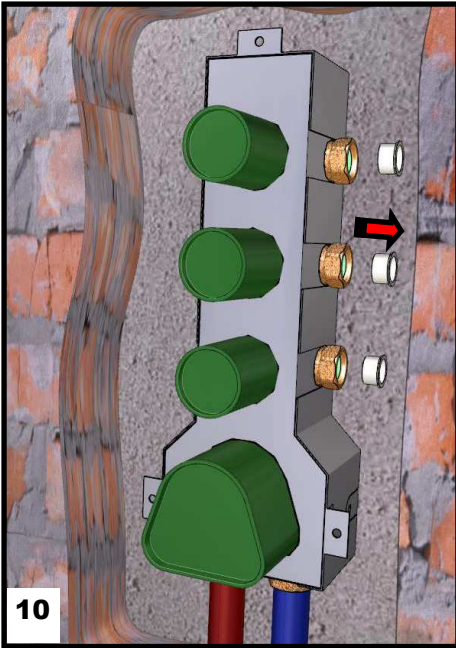

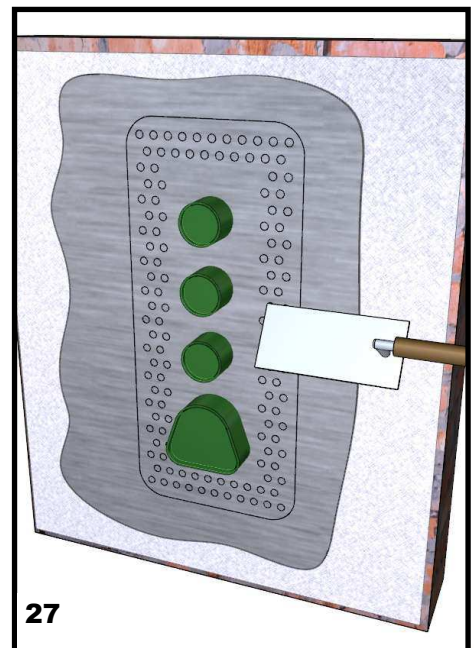
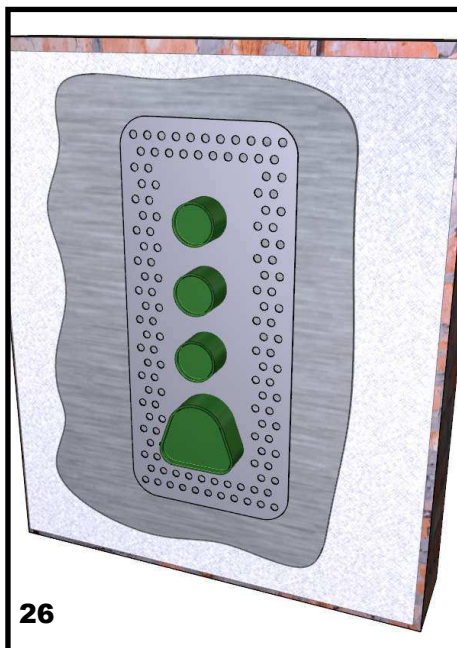
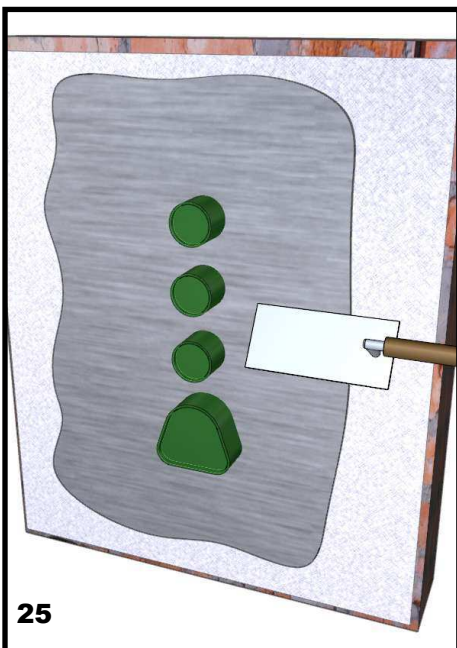
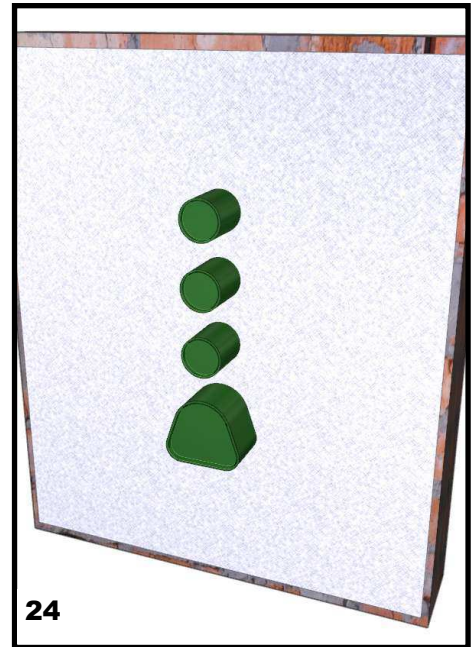
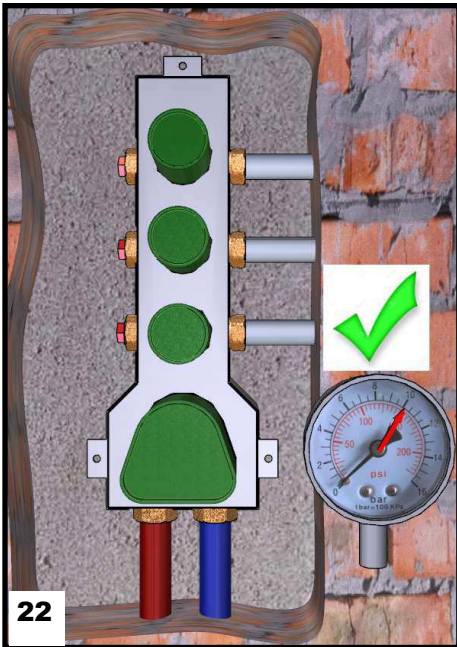
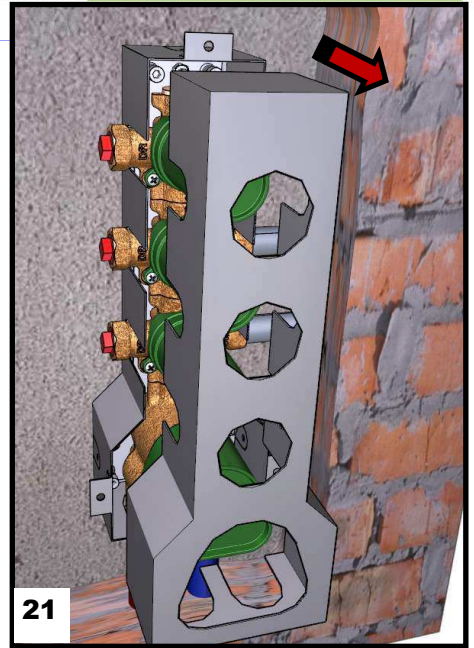
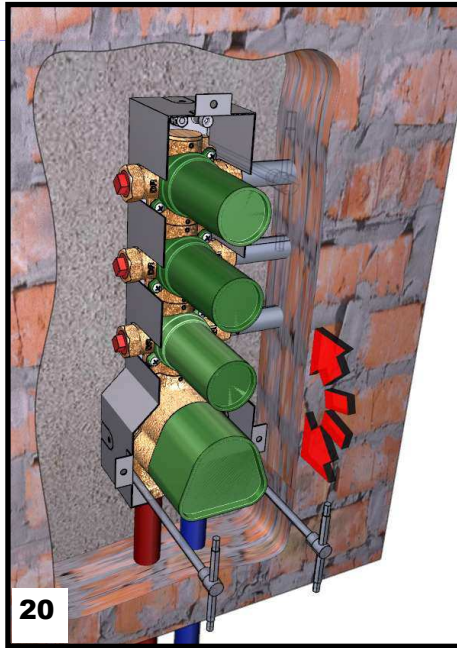
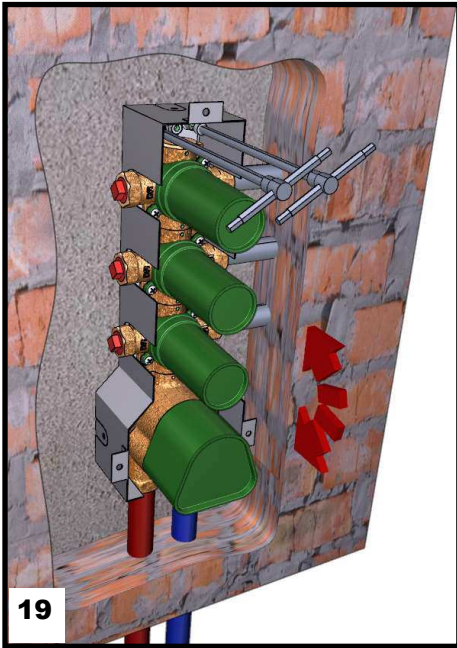

IMIS00029

