

Features

- Left-hand trip lever.
- For use with Cimarron Comfort Height® toilets.

Material

- Solid-brass construction for durability and reliability.
- KOHLER finishes resist corrosion and tarnishing.

Recommended Products/Accessories

K-23723 Faucet cleaner



ADA

Codes/Standards









ADA
ICC/ANSI A117.1

KOHLER® One-Year Limited Warranty

See website for detailed warranty information.

Available Colors/Finishes

Color tiles intended for reference only.

Color	Code	Description
	SN	Vibrant® Polished Nickel
	AF	Vibrant® French Gold
	PB	Vibrant® Polished Brass
	BGD	Vibrant® Moderne Brushed Gold
	BN	Vibrant® Brushed Nickel
	BV	Vibrant® Brushed Bronze
	BRZ	Oil-Rubbed Bronze
	2BZ	Oil-Rubbed Bronze
	BL	Matte Black
	2MB	Vibrant® Brushed Moderne Brass
	RGD	Vibrant Rose Gold
	TT	Vibrant Titanium

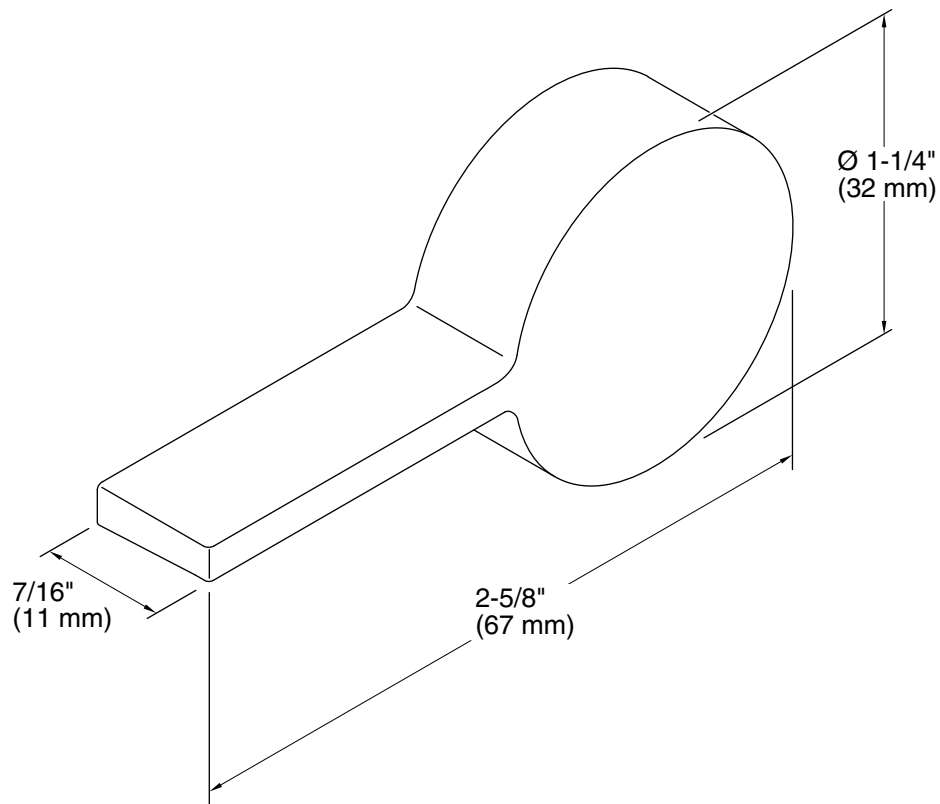

Technical Information

All product dimensions are nominal.

Material: Brass

Notes

ADA compliant when installed to the specific requirements of these regulations.