

100.2691 | Wall Mount Tub Filler Valve & Trim - 2 Volume Controls - 3/4" Thermostatic [Tub Spout & Hand Shower Outputs]

SPECIFICATIONS:

- Wall Mount Tub Filler
- Spout Projection = 9"
- Turn center knob to set temperature
- Turn right knob to activate output 1 - Hand Shower
- Turn left knob to activate output 2 - Tub Spout
- Thermostatic Valve Flow Rate - 8.0 GPM @ 60 PSI
- Hand Shower & Tub Spout positions can be swapped

STANDARDS:

- ASME A112.18.1 / CSA B125.1

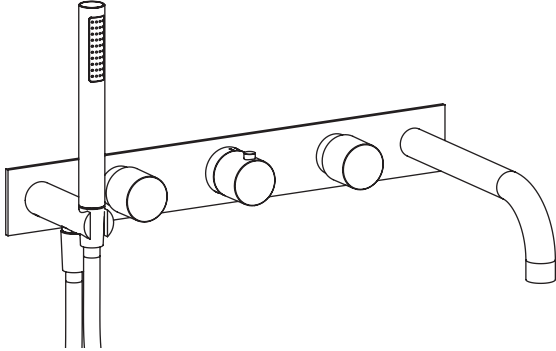

100.2691 Includes Valve [TVH.2691] + Trim [100.2691T**]

Legislation Compliance



ZeroDrip Technology



See Spec Sheet For TVH.2691 For Detailed Information On Valve.

Technical Diagram

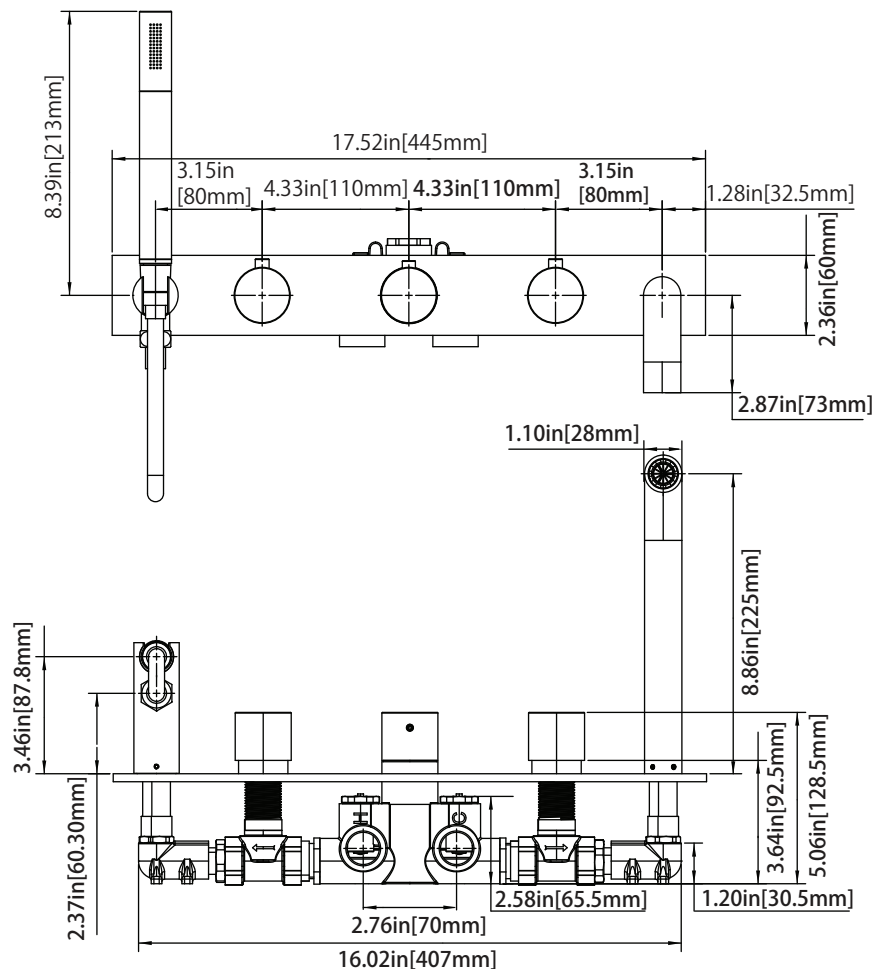

TVH.2691 | 3/4" Thermostatic Tub Filler Valve With 2 Volume Controls [Tub Spout & Hand Shower Output] Page 1 of 2

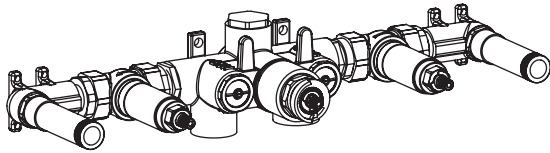

SPECIFICATIONS:

- Wall Mount Tub Filler
- Turn center knob to set temperature
- Turn right knob to activate output 1 - Hand Shower
- Turn left knob to activate output 2 - Tub Spout
- Thermostatic Valve Flow Rate - 8.0 GPM @ 60 PSI

STANDARDS:

- ASME A112.18.1 / CSA B125.1

Legislation Compliance



ZeroDrip Technology



Technical Diagram

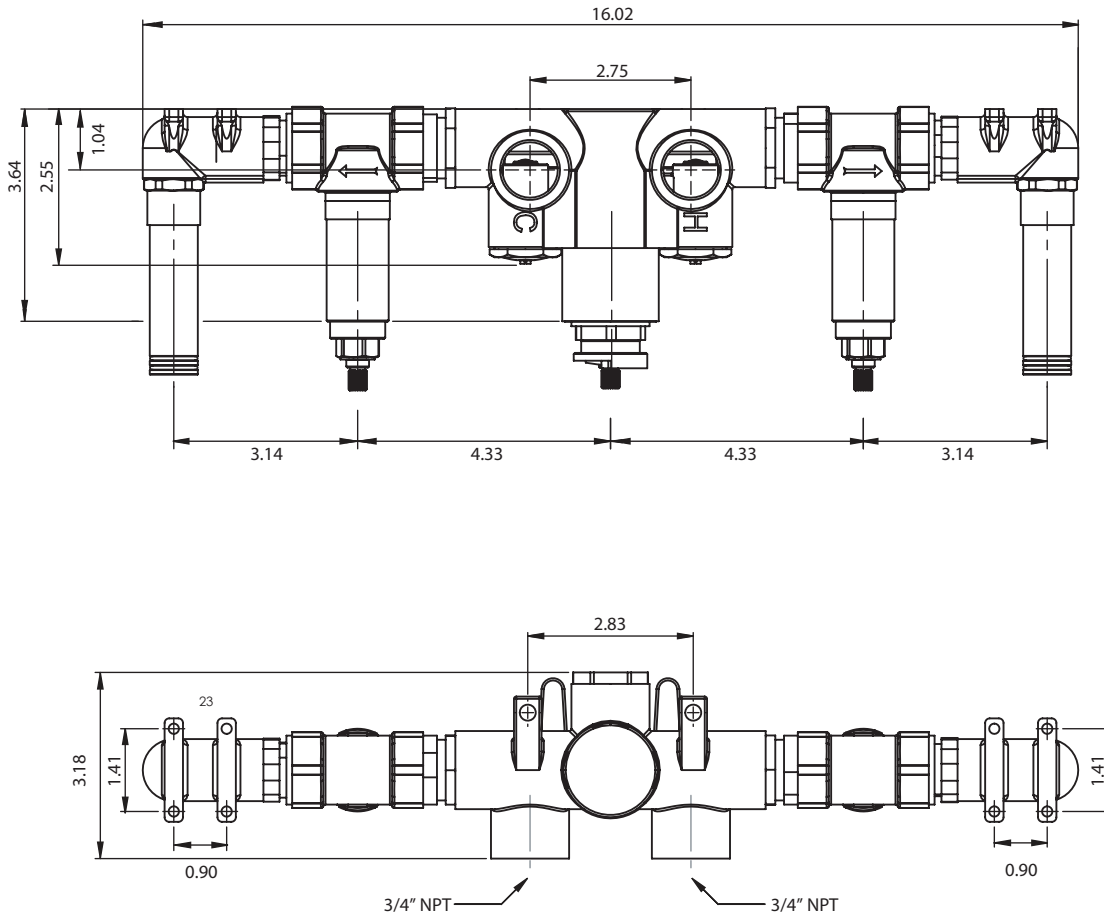



TVH.2691 | 3/4" Thermostatic Tub Filler Valve With 2 Volume Controls [Tub Spout & Hand Shower Output] Page 2 of 2

Water Diversion Diagram

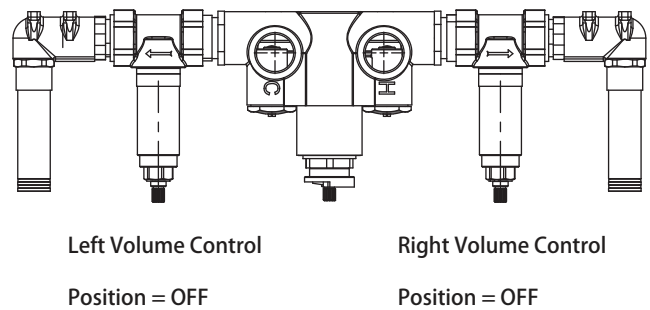
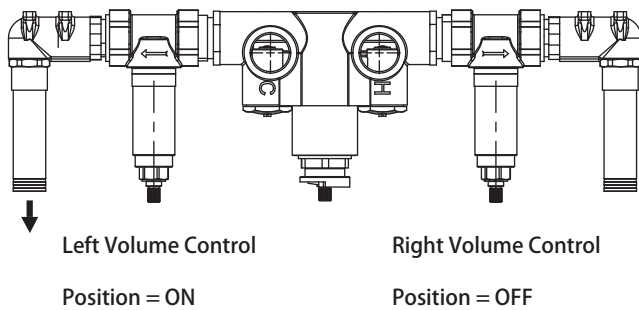
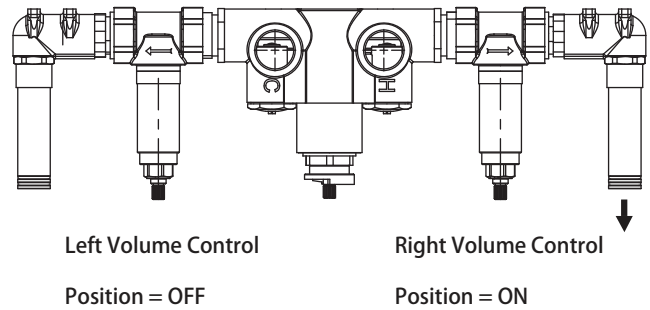
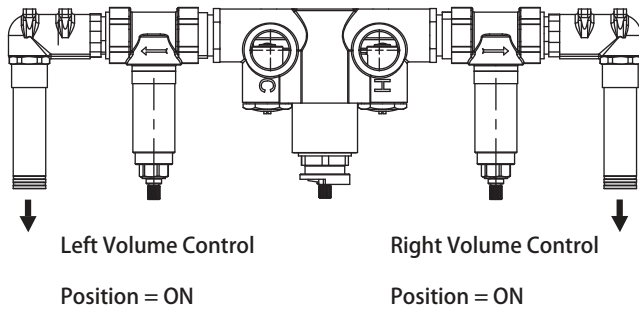

Explosion Diagram

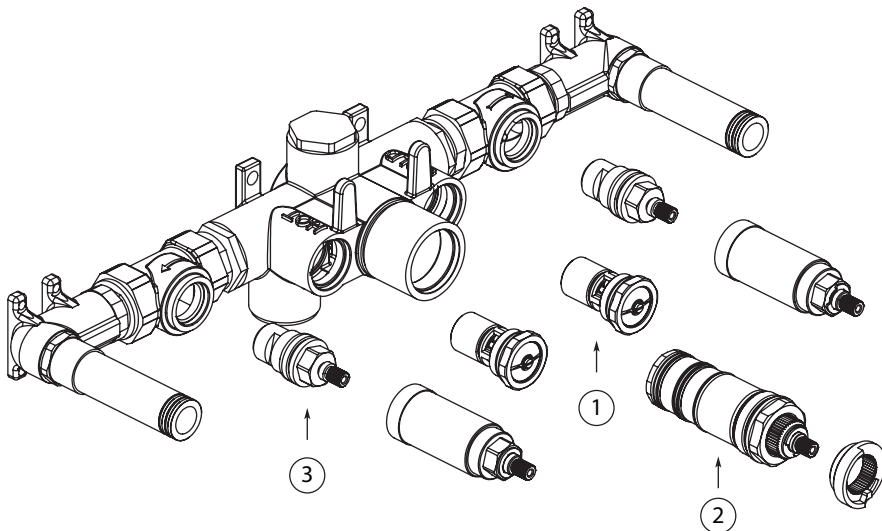

Part Number Guide:

- ① Integral Stop Kit [Pair] - TVH.4201-1987
- ② Therm. Cartridge - TVH.4201-9853
- ③ Volume Control Cartridge - TVH.4511-9853

Extension Kits*

- a) Thermostatic Handle Extension - TVH.E185CP - Chrome
TVH.EA07BN - Brushed Nickel
- b) Volume Control Handle Extension - TVH.E137
- c) Water Output Extension - TVH.E399

* QTY = 1 of 'a', QTY = 2 of 'b' and QTY = 2 of 'c' above needed for complete valve extension